	TITLE: Operating Instructions for 4-3/4" PBL (5C)		
	Document ID DSI-GL-75-009	Revision 6	Prepared By Suraj Varma DV
	Issue Date 18-08-2011	Revision Date 02-02-2018	Approved By Gernot Bauer

4-3/4" DUAL PORTED PBL BYPASS SYSTEM (5 Cycle)

OPERATING INSTRUCTIONS

RECEIVING PBL AT RIG SITE

1. On receipt of PBL Bypass Tools at Rig site, the tools should be checked for the following:
 - PBL Serial Numbers located on ID band below Ports on the Main Body.
 - Confirm rig end connections are as required.
 - Confirm Drop Ball Kit matches tool size and number.
 - Shearing pressures for Ball Seat (Deactivation Pressure) and Ports (Unlocking Pressure) are marked on tool and on Tech Sheet included in tool packet.
 - Confirm PBL Activation Ball will drift through entire drill string above PBL Tool.
 - Confirm PBL No-Go will allow passage of any required third party Activation Balls.
 - Drift the drop ball thru PBL prior to connecting BHA.
 - Remove tape covering PBL Ports prior to RIH.

2. The Drop Ball Kit that comes with each tool should contain;
 - 5 x 1-1/2" Activation Balls
 - 10 x 1-3/8" Steel De-Activation Balls
 - 2 x 1-1/8" Locking Balls
 - 1 x 1-1/2" Dart Ball

STATIC TEMPERATURE RATING OF ACTIVATION BALLS

- Torlon ball (black colour) & Fast Ball - 450 deg F (230 deg C)

The PBL will be fully tested & ready to RIH when it arrives at the rig site. A surface test is mandatory prior to rerun of tool; refer to Page-5 for Surface test instructions.

ACTIVATION PROCEDURE

1. Prior to activating the tool, **Record Pump Pressure** _____ **Pump Strokes** _____. This will be used as a reference to confirm de-activation of the tool.

2. Calculate the fluid displacement **volume and time** in the drill string to estimate when the Activation Ball will reach the PBL Bypass Tool.
 - Break drill string at rig floor and drop one (1) **1-1/2"** Activation Ball.
 - It is recommended to fill the drill string with fluid prior to dropping the Activation Ball.

3. Displace approximately 50% of the drill string volume at normal drilling pump rates then reduce the pump rate that the string pressure is 1,000 psi below the ball shearing pressure until the ball lands on the Seat.
 - In addition please consider: Flow rate should be maximum 400 gpm when ball lands on Seat (200 gpm for Fast Ball & 100 gpm for fast dart).
 - **NOTE: Care should be taken when pumping the Activation Ball down as pumping the Activation Ball on Seat at high flow rates and/or pressures may cause the Activation Ball to blow through the Seat.**

	TITLE: Operating Instructions for 4-3/4" PBL (5C)		
	Document ID DSI-GL-75-009	Revision 6	Prepared By Suraj Varma DV
	Issue Date 18-08-2011	Revision Date 02-02-2018	Approved By Gernot Bauer

- The Activation Ball will often seat sooner than the calculated pump strokes.
 - The Activation Ball has an equivalent density of 11.2 PPG (20.9 PPG for Fast Ball) drilling fluid.
 - In the event the ball does get blown through the Seat, as indicated by no change in pump pressure/strokes as recorded in Step 1, drop two (2) **1-3/8"** De-activation Balls to ensure the Activation Ball has gone through the Seat. **This step must be done prior to dropping another vinyl ball.**
 - Repeat the normal tool activation process to re-open the tool.
4. When the Activation Ball lands on Seat, the Sliding Sleeve will shift to its open position against the Spring.
- **NOTE: IT TAKES 100-200 PSI TO ACTIVATE /OPEN THE TOOL.**
 - Fluid will now be diverted through the side Ports. As long as pumping is continuous, fluid will be diverted through the Ports. If pumping is halted, the Sliding Sleeve will shift to the closed position. When pumping resumes, the Sleeve will shift open.
 - A constant, high pump rate should be maintained while the tool is in the open position. **If low flow rates, low differential pressures between drill pipe and annulus, bull heading, squeezing or similar low flow operations are required, it is recommended to de-activate the PBL Tool prior to commencing such operations.**

ACTIVATION DURING 'TOTAL LOSS'

In case of a vertical well, drop the Activation Ball and wait until the ball reaches the Seat by way of gravity (chasing the Activation Ball by pumping may cause the Activation Ball to blow through the Seat due to a combination of the suction caused by the loss zone and pumping).

In case of a horizontal well or highly deviated well, chase the Activation Ball with as low pumping as possible until it lands on the ball Seat.

DE-ACTIVATION PROCEDURE

1. Break the drill string at rig floor and drop 2 x **1-3/8"** steel De-activation Balls (It is a good practice to drop the second steel ball 5-10 seconds after dropping the first one)
2. After dropping the steel De-activation Balls, immediately start pumping at 50% of the normal drilling flow rates (200 GPM minimum) and watch for a stand pipe pressure increase. When the steel balls reach the PBL Bypass Tool, they will cut off flow through the Ports creating an immediate pressure increase.
 - It is important to Increase or maintain the same pump rate once a pressure increase is observed. DO NOT slow the pumps down once a pressure increase is observed.
 - Continue to build the pressure rapidly while continuing pumping at high constant pump rates until a pressure decrease is seen. (A pressure increase beyond the ball seat shear pressure rating is often required.)
 - The Activation Ball will blow through the Seat at +/- 10% of stated shear pressure depending upon downhole conditions. A pressure decrease is an indication the

	TITLE: Operating Instructions for 4-3/4" PBL (5C)		
	Document ID DSI-GL-75-009	Revision 6	Prepared By Suraj Varma DV
	Issue Date 18-08-2011	Revision Date 02-02-2018	Approved By Gernot Bauer

Activation Ball has blown through the Seat into the Ball Catcher. The steel balls will follow into the Ball Catcher.

- After the Activation Ball shears through the Seat, the Sleeve will move to the closed position. Circulation will now be through the BHA.
3. When pumping is resumed, check that the pressure and strokes are the same as they were prior to activating the PBL Tool (See data recorded in Step 1, above).

NOTE:

- After tripping out of the hole, the balls must be removed from the Ball Catcher Sub before RIH again. **The used Activation Balls should be immediately discarded and NEVER RE-RUN.**
- **If required, ensure float valve is in BHA below PBL or finger trap (only for completion operation) has been installed in cage to prevent movement of balls. Consult DSI if situation arises.**
- If the PBL Sub is to be rerun after being activated, it is strongly recommended to de-activate the tool prior to tripping out of the hole to minimize the wear within the tool.

EMERGENCY WEIGHTED DARTS WITH VINYL BALLS OR FAST DART (HOLLOW DART)

A Weighted Dart inserted in a 1-1/2" torlon ball or a 1-1/2" Fast Dart (Hollow Dart) are supplied as part of the kit of operating balls. These Darts are to be utilized only in cases where it is not possible to pump down the Activation Ball. These ball/darts weigh 6-7 times greater than the standard ball to facilitate quicker activation of the PBL Sub when limited or no circulation is possible.

These ball/darts MUST be dropped in direction indicated below down the drill string when activating the tool. It is not recommended to utilize the ball/dart in well bores with angles greater than 55°

Weighted Ball/Dart

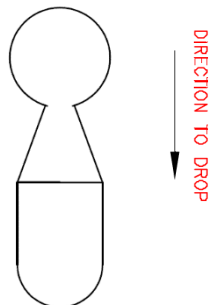

Fast Dart (Hollow Dart)

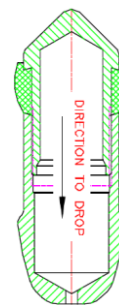

Activation & deactivation procedure is same as the standard ball. Each activation by Fast Dart (Hollow Dart) reduces the total available cycles by one.

PLEASE NOTE:

1. With little or no circulation due to partial or full blockage of the bit or BHA, the Fast Dart will descend by gravity in a well bore with a maximum inclination of up to 55 deg.
However, if the Fast Dart can be pumped down, it can be possible to get the dart to

the seat with borehole of up to 90 degrees. In horizontal wells we recommend to use the standard activation ball or the Fast Ball to activate the tool.

2. If Fast Dart (Hollow Dart) is utilized in conditions when circulation is possible, the maximum flow rate is **100 GPM** when pumping down Dart.
3. Each activation by Fast Dart (Hollow Dart) reduces the total available cycles by one.

PBL OPERATIONAL SEQUENCE



Drilling Mode
FLOW to BIT



Activation Ball
Seated

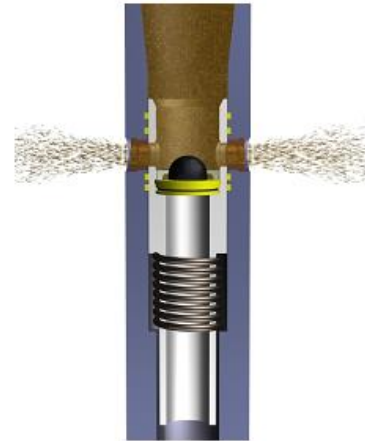

Open Position
FLOW THRU PORT



De-Activation
Balls Dropped
PRESSURE UP



Balls Sheared Thru
Seat Tool Reset



Drilling Mode
FLOW to BIT

Should there be any questions regarding the operational procedures of the PBL tool please contact a DSI representative or visit our website www.dsi-pbl.com

	TITLE: Operating Instructions for 4-3/4" PBL (5C)		
	Document ID DSI-GL-75-009	Revision 6	Prepared By Suraj Varma DV
	Issue Date 18-08-2011	Revision Date 02-02-2018	Approved By Gernot Bauer

MAKE UP and TESTING THE PBL AT THE SURFACE

(MANDATORY DURING RE-RUN OF TOOL & RIG CREW FAMILIARIZATION. Optional for initial RIH)

1. Pick up the tool and make up the Main Body to the Ball Catcher Sub.
 - Ensure that the Sleeve is in the closed position by looking through the Port on the side of the tool.
 - Ensure that the Ball Catcher cage in Ball Catcher Sub has the bevelled end facing up and no-go cage facing down.
 - Make-up torque is the same as the rotary shoulder thread connection. **(Do not Over Torque)**.
2. Lower the BHA into the hole ensuring that the Ports are below the rotary table.
3. Drop one (1) x **1-1/2"** Activation Ball to activate the tool.
 - It is recommended to fill up the drill string with fluid prior to dropping the Activation Ball; make-up Kelly to PBL Tool.
4. Engage the pump slowly and watch for the Sleeve opening and the fluid diverting through the Ports.
 - The Sleeve should function within 100-200 psi.
 - The Sleeve will return back to its original position when pumping is stopped.
5. Break the Kelly from the PBL Tool and drop 2 x **1-3/8"** steel De-Activation Balls into the top of the Tool; make-up Kelly to PBL Tool.
6. Engage the pump and record the pressure at which the Activation Ball shears through the Ball Seat. **BUILD PRESSURE RAPIDLY.**
 - This should be plus or minus 10% of the recorded pressure that was sent with the Tool.
 - The shearing pressure varies from 1,600-4,500 psi. Ensure the shear pressure is suitable for the application the tool is planned to be used.
7. With the Activation Ball sheared and the Port closed, keep pumping and lift the tool above the rotary table to visually check the Port is closed.
8. Stop the pumps, pick up string and place in the slips
 - Break the PBL Tool between the Main Body and the Ball Catcher Sub.
 - Back out Kelly/Main Body from the string and retrieve the balls from the Ball Catcher by removing Ball Catcher Cage. **Do not under any circumstances re-use the Activation Balls once they have been used in the tool.**
 - Reinsert Ball Catcher Cage and make-up Kelly/Main Body and Ball Catcher Sub before RIH.

	TITLE: Operating Instructions for 4-3/4" PBL (5C)		
	Document ID DSI-GL-75-009	Revision 6	Prepared By Suraj Varma DV
	Issue Date 18-08-2011	Revision Date 02-02-2018	Approved By Gernot Bauer

PBL SUB - DO's & DON'Ts

- All ID's of the drill string components should be larger than the diameter of the activation ball otherwise the ball could get stuck during the pumping process.
- If other ball-activated tools are used in the drill string (e.g. ball-activated reamer) please consider the "drift" of the PBL tool.
- Remove any "mud cleaning filters" before dropping the activation or de-activation balls.
- Be careful that no other objects (cement chunk, glove, part of a drill pipe screen, thread protector, etc.) get inside the drill pipe and land on the seat. These objects could act like an activation ball and improperly open the tool. It is highly recommended to place a filter in the standpipe and drill string to prevent unintended activation of the tool due to junk/debris.
- If the optional surface test is done, always ensure the PBL tool is fully within drilling fluids to avoid potential ball shattering during de-activation.
- Large diameter LCM materials can be pumped through the PBL ports. LCM size should not normally exceed 1/3 of port diameter (if in any doubt please call a DSI representative).
- It is recommended to pump the activation ball with a fluid spacer (normal drilling mud, no LCM included) otherwise LCM may pass the ball during the pumping process before the activation ball lands on the seat and LCM gets access to the sensitive BHA.
- When LCM has been pumped, it is recommended to clean the drill string (with normal drilling mud, no LCM included) from LCM before dropping the de-activation balls.
- Never re-use a previously dropped activation ball (vinyl).
- If the BHA is "packed-off" and therefore unable to circulate, the PBL tool kit contains a Fast Dart. This can be dropped to reach the seat without pumping (up to 55 degrees) and it may be possible to regain circulation through the PBL by starting the pumps and opening the PBL ports.
- Once the PBL has been activated, high flow rates can be used with pressures that are much higher than the PBL de-activation pressure. DSI recommends the use of high flow rates to fully make use of the extra cleaning power of the PBL sub or high flow to pump LCM (the de-activation pressure ONLY applies when the steel balls have been dropped to de-activate the tool & cannot be exceeded by high flow rates when the tool is open).
- If low flow rates, low differential pressure between drill pipe and annulus, bull heading, squeezing or similar low flow operations are required, it is recommended to deactivate the PBL tool before commencing such operations.
- If the PBL sub is laid down and is planned to be re-run in hole, please jet-wash fully with clean water when first POOH.
- If required, ensure float valve is in BHA below PBL or finger trap has been installed in cage (for completion operations) to prevent movement of balls.

Please fully use the running procedures and the tool service guidelines which are sent with each PBL tool (if in any doubt please call a DSI representative).

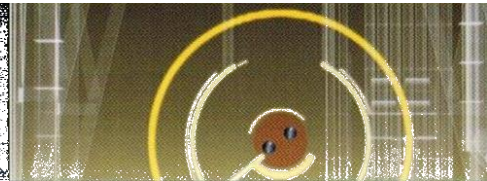

Round about 10, Street 911, Jebel Ali Free Zone, P.O. Box 30576, Dubai, United Arab Emirates

Tel.: +971 4 8808228, Fax: +971 4 8808218, E-mail: dsifze@eim.ae, www.dsi-pbl.com

A Schoeller-Bleckmann Company